

GP Serie

Solid Carbide Cutters for Graphite
VHM Fräser für Graphit



ZCC Cutting Tools Europe GmbH

your Partner | your Value

Our program

Unser Programm

The new graphite cutters for the machining of graphite electrodes

The machining of graphite materials using special tooling is now becoming increasingly popular. The graphite milling cutters from ZCC Cutting Tools are of high performance and high accuracy and enable detailed filigree and profile machining of the material to be carried out. A special 'Diamond' wear resistant surface coating is used to protect the cutters and increase performance when machining these highly abrasive graphite materials.

Die neue Graphit-Serie für die Herstellung von Graphitelektroden

Um den immer beliebter werdenden Elektrodenwerkstoff Graphit zu bearbeiten, werden spezielle Werkzeuge benötigt. Die Graphitfräser von ZCC Cutting Tools sind hochpräzise und ermöglichen die filigrane Bearbeitung des Werkstoffes. Durch die spezielle Beschichtung der Fräser von ZCC Cutting Tools werden die Werkzeuge vor dem Verschleiß durch das hochabrasive Graphit geschützt.

Non-standard made to order Sonderwerkzeuge

If you do not find the right tool for your demands in our catalogue program ZCC Cutting tools offer a 'specials' service to supply micro cutting tools exactly to customer specifications. Please send an enquiry to our technical department who will then contact you to discuss your exact requirements.

Please copy the form on page six, fill in your requirements and send it back to us.

e-mail: info@zccct-europe.com

fax: +49(0)211 - 989240-111

Alternatively, you could download the data sheet in the customer service area of our website:

www.zccct-europe.com

Falls Sie in unserem Programm noch nicht das passende Werkzeug für Ihre Bedürfnisse gefunden haben, ist das kein Problem. ZCC Cutting Tools bietet Ihnen auch individuell angefertigte Werkzeuge für die Micro-Zerspannung an, die genau Ihren Anforderungen entsprechen. Senden Sie uns Ihre unverbindliche Anfrage zu. Wir werden uns anschließend mit Ihnen in Verbindung setzen, um die Details zu besprechen.

Bitte kopieren Sie dafür das Formular auf Seite sechs und lassen Sie es uns ausgefüllt zukommen:

E-Mail: info@zccct-europe.com

Fax: +49(0)211 - 989240-111

Alternativ können Sie sich das Formular auch im Kundenservicebereich unserer Website herunterladen:

www.zccct-europe.com

All information in this brochure refers to current descriptions or features which may change owing to further product development. Descriptions and characteristics are only binding if expressly agreed on in writing at contract conclusion.

Alle Informationen in dieser Broschüre beziehen sich auf aktuelle Beschreibungen oder Eigenschaften. Sie können sich auf Grund von Produktentwicklungen ändern. Beschreibungen und Eigenschaften sind nur bindend, wenn sie ausdrücklich schriftlich im Vertrag vereinbart sind.

Pictograms Piktogramme

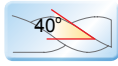

Helical angle
Spiralwinkel



Diamond-coated solid carbide. Giving 4 times to 8 times longer tool life than uncoated tools.

Diamant beschichtetes Vollhartmetall. Hiermit werden im Vergleich zu nicht beschichteten Werkzeugen 4- bis 8-mal höhere Standzeiten erreicht.

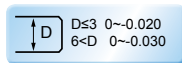

Cutter diameter tolerance
Toleranz Fräserdurchmesser



2-flute mills
2-Schneiden Fräser



3-flute mills
3-Schneiden Fräser

GP Series · GP Serie

Solid Carbide Cutters for Graphite · VHM Fräser für Graphit

2-flute router ball nose / corner radius (Diamond coated) 2-Schneider Kugelkopf / Eckradius (Diamant beschichtet)

GP-2BM-Graphite

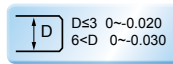
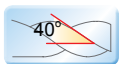
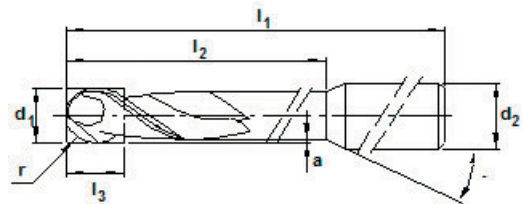

Article no. Artikel Nr.	Dimension (mm) Abmessung								
	d ₁	r	l ₃	l ₁	l ₂	d ₂	z	a	φ
599211	0,3	0,15	1,5	60	2,5	6,0	2	0,010	7,0
599212	0,5	0,25	1,5	60	3,5	6,0	2	0,010	7,0
599214	0,5	0,25	1,5	60	7,0	6,0	2	0,010	7,0
599213	1,0	0,50	3,0	60	5,0	6,0	2	0,025	7,0
599215	1,0	0,50	3,0	60	10,0	6,0	2	0,025	7,0
599216	1,5	0,75	3,0	60	10,0	6,0	2	0,025	10,0
599218	2,0	1,00	3,0	40	12,0	3,0	2	0,100	15,0
599217	3,0	1,50	4,0	60	12,0	6,0	2	0,100	15,0

Further dimensions available on request
Weitere Abmessungen auf Anfrage lieferbar

GP-2EMR-Graphite

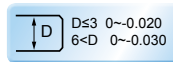
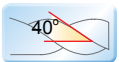
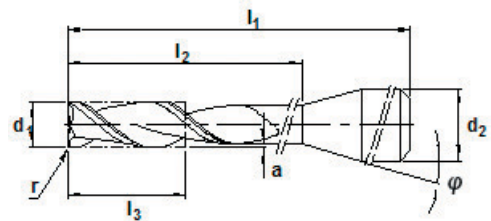

Article no. Artikel Nr.	Dimension (mm) Abmessung								
	d ₁	r	l ₃	l ₁	l ₂	d ₂	z	a	φ
599210	0,3	0,05	1,5	60	2,5	6,0	2	0,010	7
599203	0,5	0,05	1,5	60	3,5	6,0	2	0,010	7
599205	0,5	0,05	1,5	60	7,0	6,0	2	0,010	9
599204	1,0	0,05	3,0	60	5,0	6,0	2	0,025	7
599206	1,0	0,05	3,0	60	10,0	6,0	2	0,025	9
599207	1,5	0,05	3,0	60	10,0	6,0	2	0,025	9
599209	2,0	0,10	3,0	40	10,0	3,0	2	0,010	15
599208	3,0	0,10	4,0	51	10,0	6,0	2	0,010	15

Further dimensions available on request
Weitere Abmessungen auf Anfrage lieferbar

3-flute router ball nose / corner radius (Diamond coated) 3-Schneider Kugelkopf / Eckradius (Diamant beschichtet)

GP-3BM-Graphite

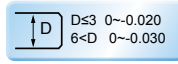
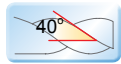
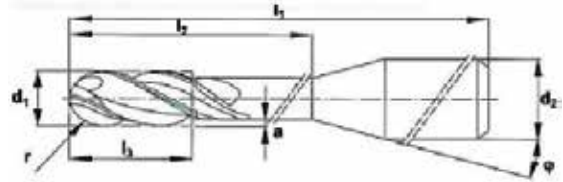

Article no. Artikel Nr.	Dimension (mm) Abmessung								
	d ₁	r	l ₃	l ₁	l ₂	d ₂	z	a	φ
599202	2,0	1,00	10,0	50	14,0	3,0	3	-	15
599201	3,0	1,50	10,0	50	-	3,0	3	-	-
599200	4,0	2,00	15,0	60	-	4,0	3	-	-
599199	6,0	3,00	30,00	78	-	6,0	3	-	-

Further dimensions available on request
Weitere Abmessungen auf Anfrage lieferbar

3 flute router
3 Schneider

GP-3EMR-Graphite

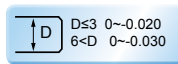
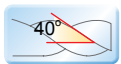
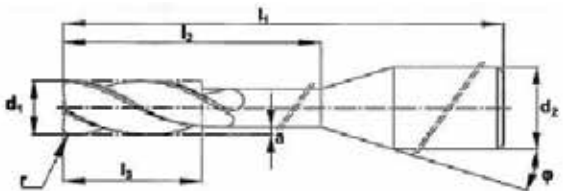

Article no. Artikel Nr.	Dimension (mm) Abmessung								
	d ₁	r	l ₃	l ₁	l ₂	d ₂	z	a	φ
599198	2,0	0,10	10,0	50	14,0	3,0	3	-	15
599197	3,0	0,20	10,0	50	-	3,0	3	-	-
599196	4,0	0,10	15,0	60	-	4,0	3	-	-
599195	6,0	0,30	-	78	-	6,0	3	-	-

Further dimensions available on request
Weitere Abmessungen auf Anfrage lieferbar

GP Series · GP Serie

Solid Carbide Cutters for Graphite · VHM Fräser für Graphit

Please copy, fill in and send it back to ZCC Cutting Tools. Bitte kopieren, ausfüllen und an ZCC Cutting Tools zurück schicken.

Fax: +49(0)211 - 989240-111, E-Mail: info@zccct-europe.com

Company <i>Firma</i>			
Street <i>Straße</i>			
City <i>Ort</i>		Post code <i>PLZ</i>	
Country <i>Land</i>			
Name			
Tel		Fax	
E-mail			

Required Tool *Gewünschtes Werkzeug*

Diameter \emptyset <i>Durchmesser \emptyset</i>		Coating <i>Beschichtung</i>	
Edges No. <i>Schneidenanzahl</i>		Yes <input type="checkbox"/>	
End edge over center <i>Schneide über Mitte</i>	<input type="checkbox"/> Yes <input type="checkbox"/> No	No <input type="checkbox"/>	

d1	d2	l1	l2	l3	r	ϕ	Number of tooth <i>Anzahl Zähne</i>

Please cross right form!

Bitte zutreffende Form ankreuzen!

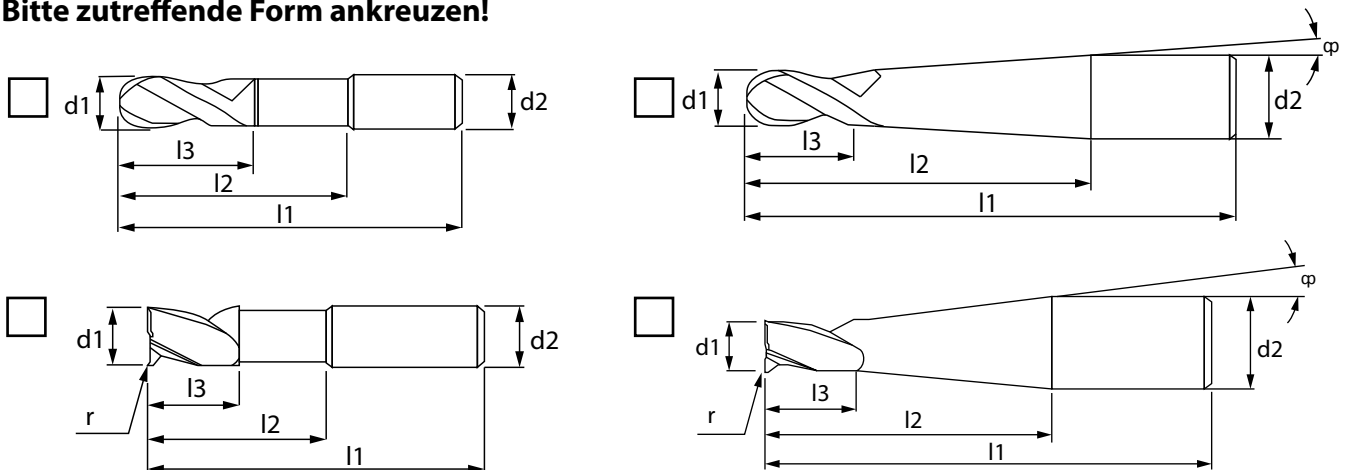

Remarks <i>Bemerkungen</i>			
Order quantity <i>Auftragsmenge</i>		Place, Date <i>Ort, Datum</i>	

Confirmation
Unterschrift

Non-standard made to order
Sonderwerkzeuge

Precision tools for micro cutting "Made in Germany"

Since its foundation in 1953 in Zhuzhou, Hunan in the People's Republic of China, ZCC-CT has developed rapidly by progressively using highly advanced modern production technology as well as having a highly qualified and committed workforce. ZCC Cutting Tools is now the largest producer of carbide cutting tools in China and one of the leading carbide manufacturers worldwide. The 'ZCC Group' now has more than 6000 employees and belongs to the 'Minmetals group' who are the 10th largest business in the whole of China and employs in excess of 168,000 worldwide.

Besides the production in China, where the majority of the high quality tools is manufactured, the micro cutting tools are directly produced in Germany. Thereby it is possible to react particularly quickly and flexibly to customer wishes. In addition to the standard program we produce tools up to a diameter of six mm exactly to customers requirements for micro cutting.

With its high quality products and constantly expanding product ranges ZCC Cutting Tools is a long-term and reliable partner in the global cutting tool industry. Using its advanced production technology, ZCC Cutting Tools products are manufactured to the highest quality standards to maintain a constant quality and high performance. The wide range of products contains tools made of carbide, CBN and PKD for all areas of machining.

For more information please feel free to contact us.
tel. +49(0)211-989240-0
fax +49(0)211-989240-111
e-mail: info@zccct-europe.com

Präzisionswerkzeuge für die Micro-Zerspanung „Made in Germany“

Seit der Gründung 1953 in Zhuzhou, Hunan in der Volksrepublik China hat sich ZCC Cutting Tools durch den Einsatz modernster Produktionstechnologien und hochqualifizierter, engagierter Arbeitskräfte schnell entwickelt. Das Unternehmen ist mittlerweile der größte Produzent von Hartmetallwerkzeugen in China und einer der führenden Hersteller weltweit. Die ZCC-Group hat 6.000 Mitarbeiter und gehört zur Minmetals Group, die das zehntgrößte Unternehmen in China ist. Für Minmetals arbeiten weltweit ca. 168.000 Mitarbeiter.

Neben der Produktion in China, wo ein Großteil der qualitativ hochwertigen Werkzeuge hergestellt wird, werden die Micro-Zerspanungswerkzeuge direkt in Deutschland produziert. Dadurch ist es möglich besonders schnell und flexibel auf Kundenwünsche zu reagieren. Neben dem Standardprogramm fertigen wir Ihnen hier genau das Werkzeug bis sechs mm Durchmesser an, was Sie für Ihre Fertigungsprobleme im Bereich der Micro-Zerspanung benötigen.

Mit den hochwertigen Produkten und den ständigen Erweiterungen des Programms ist ZCC Cutting Tools ein langfristiger und zuverlässiger Partner der globalen Zerspanungsindustrie. Auf Basis der neuesten Produktionstechnologien stellt ZCC Cutting Tools seine Produkte auf höchstem Niveau in einer gleichbleibenden Qualität her. Die umfangreiche Produktpalette beinhaltet Werkzeuge aus Vollhartmetall, CBN und PKD für alle Bereiche der Zerspanung.

Für mehr Informationen können Sie uns gerne kontaktieren.
Tel. +49(0)211-989240-0
Fax +49(0)211-989240-111
E-Mail: info@zccct-europe.com





Sales center in Europe:
Vertriebszentrale in Europa:

ZCC Cutting Tools Europe GmbH

www.zccct-europe.com www.zccct.com
Heltorfer Straße 12 40472 Düsseldorf, Germany
Tel.: +49(0)211-989240-0
Fax: +49(0)211-989240-111
E-mail: Info@zccct-europe.com



**Distributor
Vertretung**